

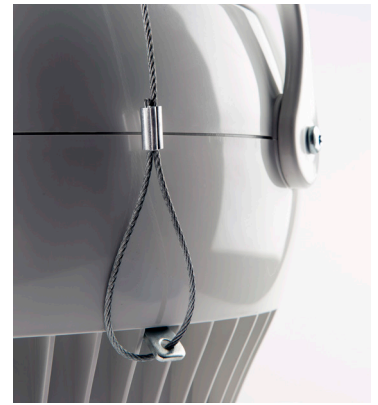

AIR PEAR

Improve comfort in your facility with a system of our best selling fans.



DISTRIBUTED COMFORT

Our most popular fan is designed to be installed as a distributed network of devices to continuously provide airflow across large spaces that suffer from stratification. The Air Pear series of fans feature our patented stator and unique nozzle design to gently throw air over long distances for ceiling to floor air rotation.

WHERE WE HELP

- › Buildings with overhead air supply
- › Spaces 15 ft+ or higher
- › Warehouses, gyms, hangars or other large spaces
- › Areas where other fans will not physically fit

Features

- › Basic shaded pole or permanent split capacitor motors
- › 4 sizes for various building heights
- › Easy installation in new construction or retrofits
- › Patented multi-vane stator and venturi nozzle
- › 3-year parts and workmanship warranty
- › 6 ft. steel leash and anchor point for safety
- › ETL Listed in U.S. and Canada
- › 5VA Flame resistance rating
- › Made in the U.S.A.

Optional

- › Manual wall mounted control
- › Smart Controller: Fixed speed, 0-10VDC, 2-20mah, or high/low temperature sensors.
- › Optional intake grille

AIR PEAR 45-P2

AIRIUSFANS.COM | 888-247-7327

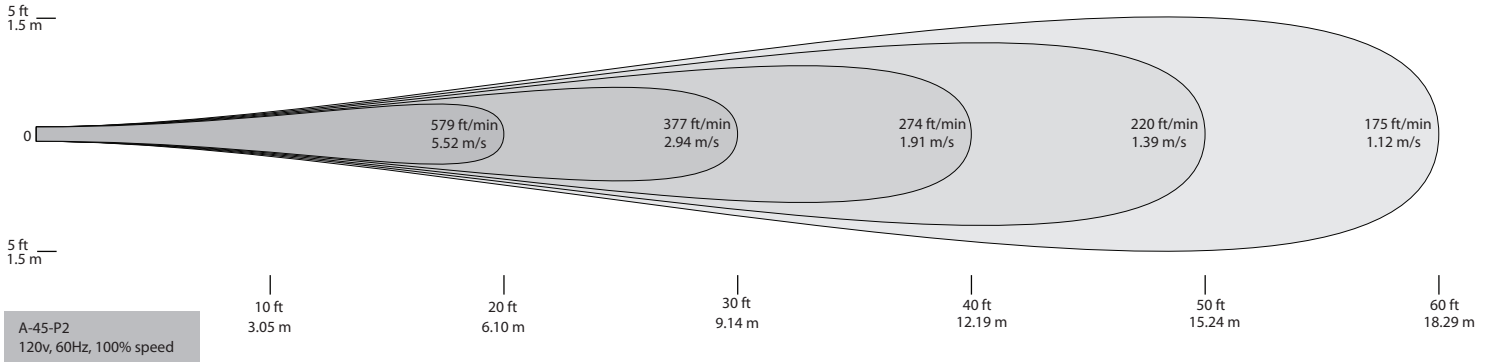

Housing: PC/ABS, 5VA flame resistance.

Motor: 250mm, permanent split capacitor, axial motor. Motor is thermally protected. Operating temperature: -13° F (-25° C) to 158° F (70° C). No lubrication required. Bearings are sealed.

Power Cord: 6 foot cord and plug provided for 120V fans, no plug for 277V.

Control Input: Mains power. TRIAC or voltage controller.

Stator: Patented multi-vane stator significantly increases air throw for maximizing performance.

Certification: Conforms to UL-507, CAN/CSA-C22.2 No. 1113. ETL listed in USA and Canada.

Safety Cable: 6' length steel cable (fastened to body)

Warranty: 3 years parts and workmanship.

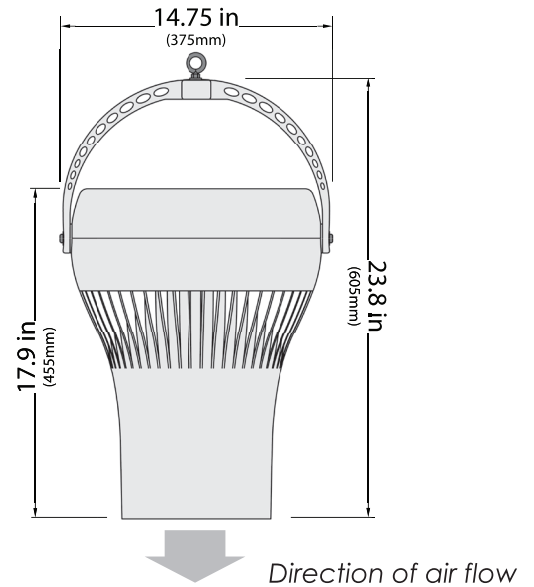

Technical Specifications



Model	Input Power, 1 Ø	Amps	Watts	RPM	dB(A) ¹	Weight	Colors
A-45-P2-STD-120-X	120VAC, 60Hz	1.6	192	2412	50, 49, 48	14 lbs.	X = Off white (W) , gray (G) or black (B)
A-45-P2-STD-277-X	277VAC, 60Hz	0.7	190	2900	50, 49, 48	14 lbs.	X = Off white (W) , gray (G) or black (B)

(1) Calculated sound pressure at 35, 40 and 45 foot distances based on non-reflective area. 81.8 dB(A) Sound Power Level, designed to meet ISO 3744 - engineering grade precision for determining sound power. Data independently verified by third party. Tests performed in-unit.

Controls & Factory Installed Options

Item	Description
TRIAC-120-1.5	Wall mounted speed control. Input voltage 120VAC, 1.5A. Four step speed control and off.
TRIAC-120-5	Wall mounted speed control. Input voltage 120VAC, 5A.
TRIAC-120-15	Wall mounted speed control. Input voltage 120VAC, 15A.
TRIAC-277-5	Wall mounted speed control. Input voltage 277VAC, 5A.
TRIAC-120-7.5	J-box mounted speed control. Input voltage 95-250VAC, 7.5A. Fixed speed, 0-10VDC or 2-20mah.
TRIAC-120-7.5-AUTO	J-box mounted speed control. Input voltage 95-250VAC, 7.5A. High/Low temperature sensors adjust speed based on delta-T
BABS	Black ABS housing upgrade for increased chemical resistance. Applications such as machine shops or pools.

Model:	Qty:
Controls/Options:	Qty: