

AIRIUS[®]

AIRFLOW REINVENTED

AIR PEAR SERIES
INSTALLATION,
OPERATION &
MAINTENANCE

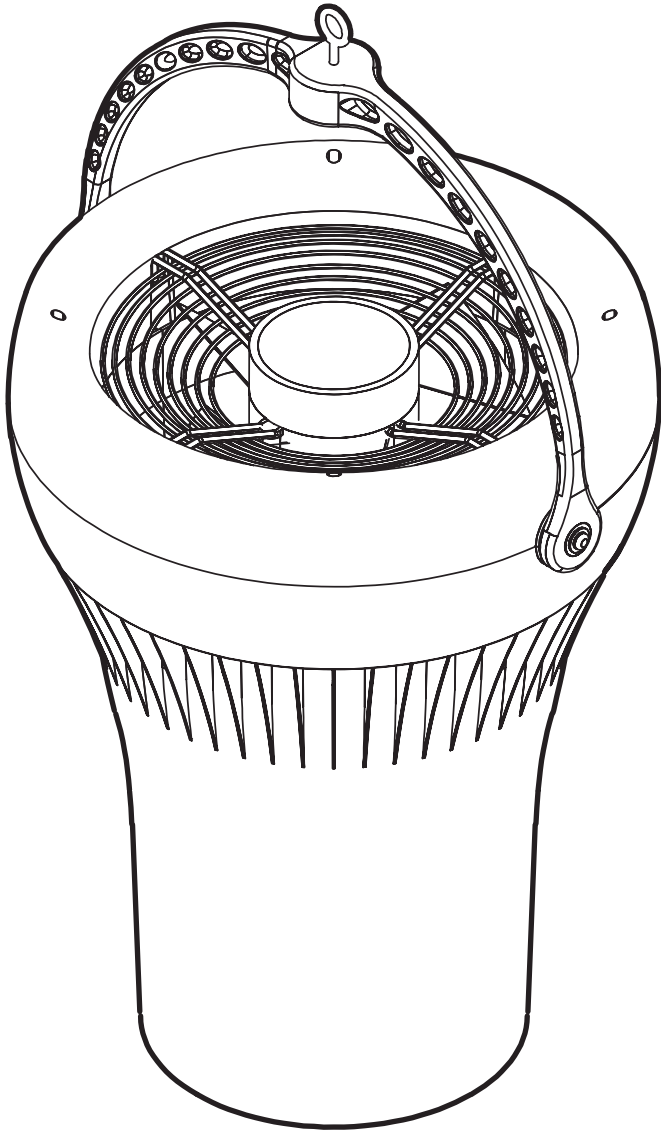

CONTENTS

- » **Introduction**
- » **Safety Precautions**
- » **Pre-Installation**
- » **Installation**
- » **Operation**
- » **Maintenance**
- » **Troubleshooting**
- » **Warranty**

Airius, LLC (Manufacturer)
811 South Sherman St.
Longmont, Colorado 80501 - USA
Toll free: 1-888-247-7327
Telephone: 303-772-2633
Fax: 303-772-8276
Email: info@airiusfans.com
Web: www.airiusfans.com

May be covered by one or more of the following
United States Patents: 7,381,129 B2; D514688
and other patents pending

AIRIUS®, AIR PEAR®, AIRIUS PUREAIR®,
PEARLINK®, and THE THERMAL EQUALIZER®
are trademarks of Airius, LLC, registered in
the U.S. and in some countries abroad. Other
trademarks pending in the U.S. and abroad.

NOTE: Carefully check fans/controls for shipping
damage. Report any damage to the carrier
immediately. Do not attempt to operate if visible
damage is evident to either the circuit or to the
electronic components. All information contained
in this manual is intended to be correct, however
information and data in this manual are subject to
change without notice. Airius makes no warranty
of any kind with regard to this information or
data. Further, Airius is not responsible for any
omissions or errors or consequential damage
caused by the user of the product. Airius reserves
the right to make manufacturing changes that
may not be included in this manual.

Air Pear Installation Guide: V1.3
©2020 Airius, LLC.

Introduction

Congratulations on the purchase of Airius' Thermal Equalizer system (Air Pear). Our patented, American-made, air-mixing system will ensure better thermal comfort in both the summer and winter while driving down expensive energy bills. We are here to support you and if you have any questions or comments, we can be contacted through our website, airiusfans.com, or give us a call: 1-888-247-7327.

About the Airius Air Pear Series

The Air Pear unit is an energy-efficient air turbine, designed to continuously move a column of air to the floor for destratification and air circulation purposes. A typical system installation includes a series of units mounted just below the ceiling, evenly spaced throughout a facility, working in concert to improve comfort and reduce HVAC energy consumption up to 35% or more*. Airius fans are available in several sizes to accommodate a wide range of ceiling heights.

* THE PERFORMANCE AND RESULTS OF THE AIR PEAR SYSTEM ARE SUBJECT TO MANY VARIABLES SUCH AS, BUT NOT LIMITED TO, AIRFLOW OBSTRUCTIONS, THE INTERIOR ENVIRONMENT, EXTERIOR ENVIRONMENT, CONDITION OF BUILDING STRUCTURE, HVAC SYSTEM PERFORMANCE AND/OR ELECTRICAL SERVICE AND THUS, ACTUAL RESULTS MAY VARY.

What's In the Box

Each unit will arrive in its own box, fully assembled. NOTE: 120VAC versions come with a three-prong plug, and other voltages have no plug supplied. You will need to have a qualified electrician either wire the desired plug on to the power cord or hard wire directly to the power circuit. We recommend using a plug for easy removal during maintenance.



Safety Precautions - Read & Save



Warning! - To prevent fire, electrical shock or injury, please observe the following:

Electrical work must be performed by a qualified person(s) in accordance with all national and local codes/standards.

Air Pear® Thermal Equalizer® fans
Models 10, 15, 25, 45, 60, &100: all voltages

120V Models:

Supplied with a polarized/grounded plug molded to a 6 ft. (1.8 m) cord. To reduce the risk of electrical shock, this plug is intended to fit in a polarized/grounded outlet only one way. If the plug does not fit fully in the outlet, contact a qualified electrician. Do not attempt to defeat this safety feature.

230V & 277V Models:

Supplied with a 6 ft (1.8 m) cord with a 3-wire pigtail for attachment to a single phase plug rated for the correct voltage; NEMA type: L6-20P or similar, wire color code: UL/CSA: black-live/white-neutral/green-yellow-earth.

Warning! To prevent electrical shock and/or injury, unplug/disconnect unit from power source before you move unit, service unit or remove any part of housing.

Warning! To reduce the risk of fire or electrical shock, do not use models 10, 15 and 25 equipped with shaded pole motors or models 45, 60 and 100 with permanent split capacitor (PSC) motors with any unapproved solid-state speed control device. Models 45, 60, 100 and 125 with electrically commutated motors (labeled as EC or EL) are capable of variable speeds with the proper controls. Contact Airius for additional information regarding variable speed controls and options.

Do not carry the Air Pear/Designer Series unit by the cord. Do not use the cord as a handle. Do not use the cord to attach or hang the product. Be sure to grasp the plug, not the cord, when disconnecting this unit from an electrical outlet.

Do not use this product if it has a damaged cord, faulty plug or any broken housing or motor component. If the supply cord, plug, motor or housing is damaged, it must be serviced or replaced by Airius, its service agents or similarly qualified persons to avoid a hazard.

To prevent damage, which may result in fire or shock hazard, do not expose this product to rain or direct moisture. Do not immerse product into water or allow water to drip into the motor housing. Do not install outdoors or in an area open to the weather. Shut off power to a wet motor at source before servicing.

Spinning blades may inflict eye or other physical injury. Always replace a damaged blade. Disconnect unit from power source first. Contact Airius for replacement blades. Plastic blades are rated 5VA, the highest fire-resistant rating for plastics, and they will not maintain a flame.

Caution! Some Air Pear products have an unguarded impeller/fan blade. Do not use in locations readily accessible to people or animals. Blades may inflict injury when moving or stationary.

To reduce the risk of injury to persons, install product so that bottom of moving fan blade or the lowest moving part is at least 8.2 ft. (2.5 m) above the floor or grade level.

The motor is thermally protected; overheating will cause the motor to stop operating. The motor may restart once normal operating temperatures are achieved. If motor fails to restart, disconnect motor from electric source and contact Airius. Do not disable this safety device or override this safety feature; doing so will void the warranty.

Do not use any PVC product (electrical tape) with the fans. If installing a fan in an environment with cutting oils in the air (production machine shop) contact the factory for assistance at 303-772-2633.

Do not position product near furnaces, fireplaces, stoves or other high temperature heat sources. Do not position Air Pear unit such that the downward air column created by the Air Pear will be directly bisected by another source of air flow, such as from another fan or from an open supply register. Do not position the unit close to other objects that will interfere with fan operation. Do not allow fan blades to come into contact with objects that can lock or inhibit the rotor operation.

Service and installation: No lubrication is required. Bearings are sealed. Bail adjustment can be made with a T-30 Torx driver/wrench, or a 5/32" Hex wrench may be used. Other tools for service: T-20 Torx (7/64" Hex) & T-25 Torx (1/8" Hex) and a #2 Phillips screwdriver.

Safety Precautions Continued

The Air Pear unit is designed to be used with only the electrical voltage identified on the label located in the nozzle and on the bottom of the motor. Connecting to any other voltage could damage the motor and create an electrical hazard and will void warranty. If you have a question, please contact the factory.

Assembling Suspended Ceiling units: See additional instructions for kit included with this pamphlet or located in box containing kit.

Important: Install with hanging device or fastener rated for a minimum of 5x the weight of the unit. Never use zip ties to hang the fan. Use care when positioning the unit. To maximize performance, make sure the airflow is unobstructed into the top of the unit and the downward airflow is unobstructed and allowed to reach the floor.

Cleaning: Unplug unit from power source first to prevent electrical shock and to avoid injuries from spinning blades. Caution: Stationary blades can cause injury! You may clean the plastic housing with a warm cloth, using mild detergent only. Do not use petroleum products, thinners, solvents, ammonia, alcohols or other chemicals to clean any part of the Air Pear unit.

USA & Canada – ETL file #3164849 EU - CE

For additional information about Air Pear® or Designer Series Thermal Equalizer® fans and other products/accessories visit:

www.airiusfans.com

Pre-Installation

Electrical

ELECTRICAL WORK MUST BE PERFORMED BY A QUALIFIED PERSON(S) IN ACCORDANCE WITH ALL NATIONAL AND LOCAL CODES/STANDARDS.

Airius recommends installing a dedicated circuit only to be used with the Air Pear units. DO NOT wire the units into the lighting circuit, as the system will cycle on and off with the lights, greatly reducing the system's effectiveness.

Outlets are available in many configurations, check with the local electrical contractor to determine the preferred type for the facility. Outlets should generally be mounted vertically unless a "twist/locking" type is being used.

To confirm electrical continuity, if possible, plug the Air Pear system into an energized outlet at floor level, similar to the outlet installed in the ceiling, before permanently mounting the Air Pear in the ceiling. Only energize the fan after hands/fingers or loose clothing are removed from/around the fan intake.

CAUTION – Make sure the fan voltage matches the intended power supply before installing. Connecting the fan to the wrong voltage will void warranty.

Mechanical

A ladder, scissor lift or other suitable means of reaching the installation point will be required.

The Air Pear system is designed to hang vertically 12-to-18 inches below the ceiling of the facility with the discharge pointing to the floor for maximum thermal equalization. NOTE: The bail may be angled, as it is ratcheted for special situations where a vertical air column is undesirable and an angled column would be more effective.

Make sure the air column will have an unimpeded path from the discharge to the floor. **If using the fans in a grocery aisle application, mount the fan a minimum of 3 ft. from the edge of any open reach in case to minimize the possibility of introducing air into the case.**

The free-hanging units are designed to hang vertically and freely from the ceiling on hardware capable of supporting a minimum of five times the weight of the unit. Example - 1/4" (7 mm) diameter steel bolt is rated at a 60 lb. (27 kg.) load.

Hardware that may be used to hang the unit includes, but is not restricted to: hooks, chains, cables, carabiners, bridle rings, beam clamps and bolts. Roof structure, building construction, electrical outlets/service and accessibility will define the appropriate hardware for each installation.

If installing within a suspended ceiling, make sure there are no objects (ducts, sprinklers, conduit, etc.), for clearance purposes, directly above the proposed location of installation and relocate if necessary.

Tools Needed

T-30 Torx Driver (5/32" Hex); other tools include T-20 Torx (7/64" Hex); T-25 Torx (1/8" Hex); #2 Phillips Driver. All necessary tools to install mounting hardware (varies from installation to installation)

Installation

Power Requirements

Refer to individual product data sheets or reference the label installed within the fan nozzle.

Branch Circuit Protection

The Air Pear fans do not include fuses for branch circuit protection. The branch circuit must have a dedicated circuit breaker or similar device. National and local safety standards and electrical codes may determine additional requirements for installation.

Fan Control

Refer to the installation and operation instructions for the specific fan control that was purchased with your Airius Fan system.

In general, any model with a shaded pole or PSC motor will be controlled over the mains power.

Any EC motor will be controlled by low voltage 0-10VDC. Airius offers several control interfaces for manual, wireless, BACnet/IP control of EC fans. For additional details, please reference our website airiusfans.com

White - tachometer - 1 pulse/revolution
Red - +10VDC
Yellow - Signal - accepts 0 to +10VDC
Blue - Common

To run an EC fan at full speed, connect the yellow and red control wires.

Plug Wiring (230/277VAC)

120VAC cord is supplied with a molded three-prong polarized/grounded plug. **DO NOT DEFEAT** this SAFETY DEVICE or modify the plug in any way.

230/277VAC no plug supplied. When fitting a plug always ensure that all relevant local regulations/electrical codes are understood and followed with care - if in any doubt seek expert guidance.

The power cord is a three-wire 18 AWG (or 16 AWG) 300VAC rated electrical cord UL rated in North America (NA) as SJT or for CE/EU compliance rated as HO5VV.

The three wires in the power cord are color-coded to ensure proper wiring as follows:

BLACK or BROWN = HOT/ELECTRIFIED/LIVE

WHITE or BLUE = "N" NEUTRAL/RETURN PATH

GREEN or YELLOW-GREEN = GROUND/EARTH

The cord is attached to the fan motor via two power leads with insulated 1/4" quick connects.

The cord is secured in the housing by a strain relief and knotted inside the housing for additional security.

Procedure for wiring the plug in a single-phase electrical system:

Use CAUTION when wiring/attaching the plug (Male Connector) to the Air Pear/Designer Series system or when using any electrical device.

1 Plug should be rated for 230VAC or 277VAC and fit properly into outlet (female connector) being used for power.

2 To avoid electrical shock, **DO NOT** plug device into energized outlet until all exposed wires and connecting terminals are enclosed by plug housing. See plug manufacturer's instructions.

3 Locate the three stripped wires on the 300VAC rated power cord attached to the unit where the outer cord insulation jacket has been removed. Wires are coded as follows: black or brown is HOT/Live (the energized conductor), white or blue is neutral "N" (the conductor used for a return current path) and green or yellow/green is ground/earth (the conductor to connect to the earth).

4 Using the plug manufacturer's instructions, locate the proper positions to attach the color-coded wire to the color-coded or otherwise

appropriately labeled terminals on the plug.

5 Tighten all connections. Reassemble plug in accordance with plug manufacturer's instructions.

To confirm electrical continuity, if possible, plug the Air Pear system into an energized outlet on the ground, similar to the outlet installed in the ceiling, before permanently mounting.

NOTE: The Air Pear System can be wired directly to a junction box but only by a qualified electrician or similarly qualified person. Always ensure that all relevant local regulations/electrical codes are understood and followed with care - if in any doubt seek expert guidance. Check local electrical codes. The preferred system is designed with a plug for easy service and cleaning. An on-off switch must be installed in the circuit to be able to disable the power to prevent electrical hazard when servicing the appliance.

Suggested Installation Methods

Hardware that may be used to hang the unit includes, but is not restricted to: Hooks, chains, cables, carabiners, bridle rings, beam clamps and bolts. Roof structure, building construction and accessibility will define the appropriate hardware for each installation. Mount the fan as high in the ceiling as possible and do not restrict airflow into the intake.

After ensuring the Air Pear system is firmly attached and after **REMOVING YOUR HANDS FROM THE UNIT**, ONLY THEN is it safe to plug the unit into the power source using the approved plug to confirm function and electrical continuity.

NOTE: Secure the power cord to the ceiling structure as added security. The cord will act as a safety leash and by securing it the possibility of the plug accidentally coming out of the outlet is greatly reduced. A 50 lb. (20 kg.) rated Zip Tie or several wraps of mechanics wire are examples of methods of securing the power cord.

Suggested Installation Methods

1 Remove the Air Pear from its box, then remove the plastic protective bag. The bail (handle) is attached via two Torx screws. Using T-30 Torx driver, loosen these screws enough so the bail may swing.

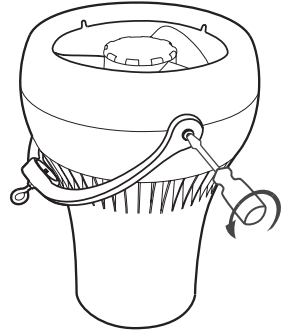

2 Swing the bail to the vertical position and re-tighten the two Torx screws.

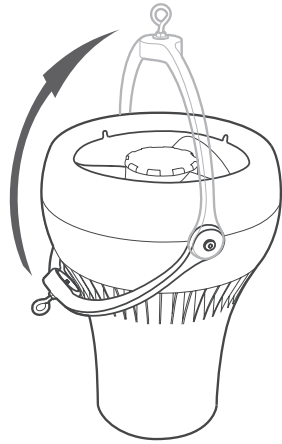

3 The Air Pear system is designed to hang vertically and freely 12-to-18 inches, or as close as possible, from the ceiling on professionally installed hardware, for models 10/15/25, capable of supporting a minimum of five times the weight of the Air Pear unit, 60 lb. (27 kg.). Example - 1/4" (7 mm) diameter steel bolt is rated at 60 lb. (27 kg.) load.

A feature of the Air Pear system is its flexibility. Hardware that may be used to hang the unit includes, but is not restricted to: Hooks, chains, cables, carabiners, bridle rings, beam clamps and bolts. Roof structure, building construction and accessibility will define the appropriate hardware for each installation.

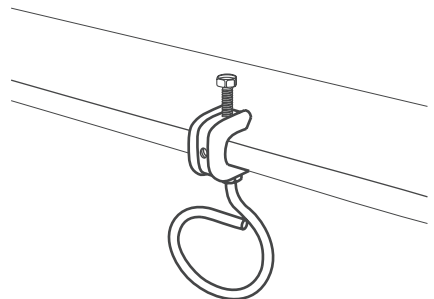

4 After ensuring the Air Pear system is firmly attached, remove your hands from the unit.

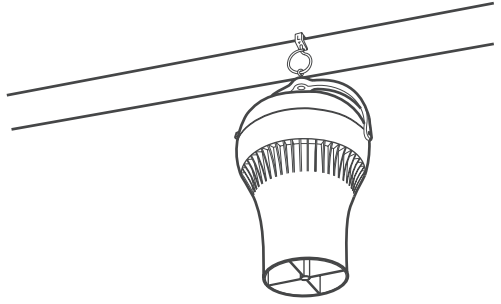

5 It is then safe to plug the unit into the power source using the approved plug to confirm function and electrical continuity.

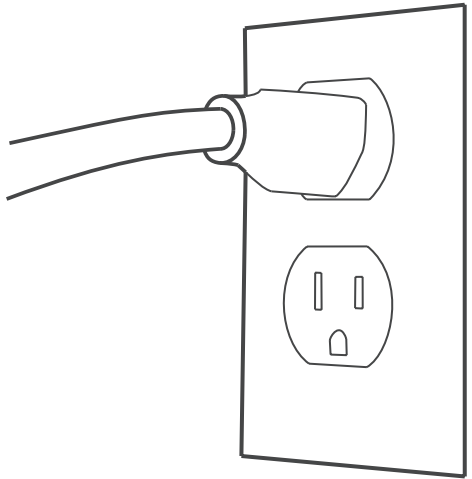

6 NOTE: SECURE the power cord to the ceiling structure as added security. The cord will act as a safety leash and by securing it the possibility of the plug accidentally coming out of the outlet in the future is greatly reduced. A 50 lb. (20 kg.) rated Zip-Tie or mechanics wire are examples of methods of securing the power cord.

The graphic to the right is an example of hanging the Air Pear unit:

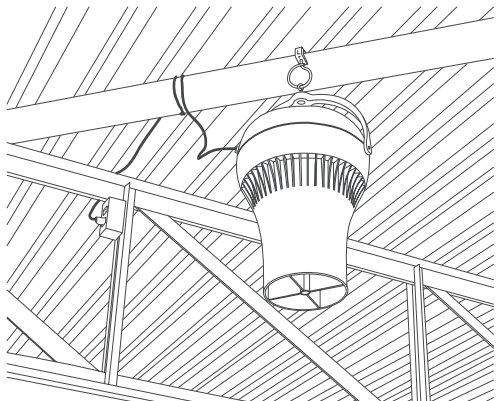

Operation

Heating Season

Within an enclosed building space, with minimal air movement, hot lighter air rises to the ceiling while cold heavier air falls to the floor creating a temperature gradient. This condition will cause excess energy use as the HVAC system fights to maintain the thermostat set point typically at 5 ft. above floor level. This inefficient condition can also cause great thermal discomfort for the building occupants.

The Air Pear is an energy-efficient air turbine, designed to continuously move a column of air to the floor. A typical Air Pear installation includes a series of units mounted just below the ceiling, evenly spaced throughout a facility, working in concert to balance the air temperature ceiling to floor and wall to wall.

As air circulation improves and air temperatures balance, your HVAC system will require less and less energy to comfortably heat the work area, reducing the energy consumption of HVAC systems up to 35% or more. Once started, the entire process of “thermal equalization” will take, on average, less than 24 hours.

All Air Pear fans are designed to run continuously, year-round, to maintain thermal equalization and general air movement.

Cooling Season

We tend to think stratification occurs only in the heating season, but actually the condition exists year round. As you mechanically condition the air to combat rising outdoor temperatures, combined with minimal air movement, a large temperature gradient can exist.

The HVAC system will consume more energy as it fights the temperature gradient, hot and cold spots and short cycling compared to a properly mixed space. Using the Air Pear system will help alleviate the problem through thermal equalization. Keeping the thermostats satisfied longer and creating air movement that produces a cooling effect on the skin will result in the ability to raise the thermostat set points as much as 6° F, yielding up to an 18% energy savings during cooling seasons.

In non-air conditioned spaces, the Air Pear system can be used for spot cooling and general air circulation.

All Air Pear fans are designed to run continuously, year-round, to maintain thermal equalization and general air movement. The fan speed can

be maintained the same throughout the year or increased for the summer months to enhance the evaporative cooling effect if people in the space find this to be desirable.

Maintenance

Follow these easy steps to prevent any excess dirt buildup and preserve the life of the product:

No lubrication is required as bearings are sealed.

Cleaning:

Caution: Stationary blades can cause injury!

Unplug unit from power source first to prevent possible electrical shock and prevent injuries from spinning blades.

You may clean the plastic housing with a damp cloth, using mild household detergent only.

DO NOT use petroleum products, thinners, solvents, ammonia, alcohols or other chemicals to clean any part of the Air Pear unit.

Note: If fan is not operating or any parts are broken, contact manufacturer for replacement information.

Troubleshooting

The Airius products are tested before they leave the factory, resulting in an extremely low rate of returns. However, mechanical devices do fail, and we recommend that you identify the problem and try the simple suggestions below.

Fan will not start:

- a) Check fuses and circuit breakers.
- b) Check voltage at fan connection.
- c) Check speed control connections
- d) Contact manufacturer for additional help: 1-888-247-7327.

Fan airflow is too fast/slow:

- a) Adjust speed control to produce desired flow.

Fan has excess vibration (noise or wobbles):

- a) Make certain the hanging hardware is secured tightly.
- b) Contact manufacturer for additional help: 1-888-247-7327

Airius Warranty Policy

This warranty is limited to products purchased directly from Airius, LLC ("Airius") or one of its authorized resellers. To determine whether a reseller is authorized, please contact Airius at the contact information below. Airius warrants products listed below will operate properly and be free of defects in materials and workmanship according to the following terms:

Products Warranty Period

Air Pear Series Fans 3 Years (All Parts/Components)

Speed Controllers 1 Year (All Parts/Components)

Photohydroionization Cell 2 Years (All Parts/Components)

These include new units or units rebuilt under Airius' factory refurbish program. Airius will repair or replace such units, at Airius' sole discretion, if there is any defect in their materials or workmanship caused by Airius during the warranty period. With respect to replacement or repair rendered, Airius warrants that the parts replaced or repaired will operate properly and be free from defects in materials and workmanship for the remainder of the original warranty period.

Definitions:

1. The "warranty period" shall begin on the shipping date from the Airius factory to the customer (end user) .
2. "Operate properly" applies to mechanical, electrical and structural functions only. No guarantee is made regarding the quantity of air movement or the appropriateness or the effectiveness or merchantability of any product for its intended purpose or for the customer's particular application.

Exclusions:

Any of the following actions will constitute a breach of and will void all warranties:

1. Improper delivery, installation, or maintenance, including, but not limited to:
 - a. Failure to follow the required installation procedures specified in the Airius "Installation Guide" and in all other documentation supplied with the fans and related equipment, including documentation provided by the manufacturers of the individual fan and control components;
 - b. Failure to follow all applicable codes and ordinances, including, but not limited to the National Electric Code and state and local building codes;
 - c. Failure to follow electrical engineering industry standards regarding the approved method of installing electrical equipment having the characteristics of the fans, the fan controls, and their related components, even if such standards are not explicitly referenced in any literature supplied by Airius or provided by the manufacturers of the fan and control components.
2. Any modification or alteration of, or adjustment to the fans, fan controls, and/or any disassembly of the components of the fans and fan controls for any purpose whatsoever, including any attempt to diagnose and/or repair any problem, without prior written authorization from Airius. Such disassembly includes, but is not limited to, separation of the motor from the housing assembly and/or removal of any electrical component from the fan controller unit.
3. Installation of fans into a detrimental environment with airborne oils / cutting fluids / solvents that may attack the base resin or motor, unless:
 - a. Airius has provided written authorization prior to installation.
4. Misuse, abuse, accidents, unreasonable use or Acts of God.
5. Incorrect electric current, voltage or supply.
6. Failure to use fan controls supplied by Airius, unless:
 - a. Airius has provided written authorization prior to installation; and
 - b. The fan controls are built, operated and maintained according to specifications provided to and approved by Airius.
7. Failure to perform periodic maintenance as detailed in the Airius "Installation Guide."

8. Consequential or incidental damages sustained by any person or entity as a result of any breach of these warranties are also excluded, except where such damages may not be excluded by law.

Acquiring Warranty Service

Do not return any item without first being assigned a Return Material Authorization (RMA) tag number. Customer must obtain a RMA# from Airius (888-AIR-PEAR or info@airiusfans.com) before returning the faulty unit. RMA number must appear on the return-shipping label and be associated with any correspondence. Customer is responsible for all return shipping costs to:

Airius Warranty - RMA# ____
711 South Lincoln Street
Longmont, Colorado 80501

Airius will return the unit(s) freight prepaid. Airius may elect to repair the same unit at customer site or offer replacement parts to facilitate repair and reduce customer down time and expense. Airius is not responsible for misuse of their product.

Freight claims are the responsibility of the customer and all products are shipped FOB Longmont, Colorado, USA.

Remedy and Limit of Liability

The exclusive remedy of the purchaser, and the limit of liability for Airius, for any and all losses in connection with this product shall be repair or replacement of the warranted product or the affected components, as provided above.

Airius reserves the right to make the final determination, based on its own assessment, as to (1) whether the problem in question is the result of a defect in design, workmanship or materials, and not the result of error, misuse or abuse on the part of the customer, as set forth under the exclusions detailed above; (2) whether the problem or defect is material and requires action under this warranty; and (3) whether the remedy of repair or replacement is appropriate.

With regard to electrical and electronic components provided by Airius that comprise part of the products, including motors, Airius relies on the determination by the original manufacturer as to whether the failure of such component was the result of a defect. If the manufacturer of such component determines that there was no defect and therefore refuses to cover it under warranty, Airius likewise will not warranty such item.

THIS WARRANTY IS EXPRESSLY IN LIEU OF ALL OTHER WARRANTIES, EXPRESS OR IMPLIED, INCLUDING ANY WARRANTY, REPRESENTATION OR CONDITION OF MERCHANTABILITY OR THAT THE PRODUCTS ARE FIT FOR ANY PARTICULAR PURPOSE OR USE, AND SPECIFICALLY IN LIEU OF ALL SPECIAL, INDIRECT, INCIDENTAL, OR CONSEQUENTIAL DAMAGES. REPAIR OR REPLACEMENT SHALL BE THE SOLE REMEDY OF THE CUSTOMER AND THERE SHALL BE NO LIABILITY ON THE PART OF AIRIUS FOR ANY SPECIAL, INDIRECT, INCIDENTAL, OR CONSEQUENTIAL DAMAGES, INCLUDING BUT NOT LIMITED, TO ANY LOSS OF BUSINESS OR PROFITS, WHETHER OR NOT FORESEEABLE.

Any and all disputes related to this warranty or any other matter related to Airius must be submitted to binding arbitration within 45 radial miles of Longmont, Colorado. The arbitrator will follow the Colorado Uniform Arbitration Act and the Rules of the American Arbitration Association. Under Colorado law, punitive damages are not recoverable by any party subject to arbitration. Moreover, jury trials are not available in arbitration. The arbitration decision or award is legally binding and enforceable. To the extent that a court rules that this paragraph is not enforceable, the parties agree to resolve any and all disputes in the Boulder District Court in Boulder, Colorado.

Customer Service: 888-AIR-PEAR (888-247-7327) or info@airiusfans.com

